

EYP-RWE-0670-00703-1000-SOT02-0000

Revision 1.22

2021-05-19

GAIN CHIPS AR coated Fabry-Perot Laser



General Product Information

Product	Application
tunable 670 nm Fabry-Perot Laser for use in an External Cavity Diode Laser (ECDL) sealed SOT Housing	Li Spectroscopy at 671 nm also covering 668 nm
Monitor Diode	

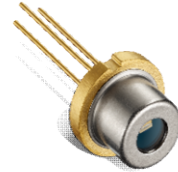

Absolute Maximum Ratings

Parameter	Symbol	Unit	min	typ	max
Storage Temperature	T_S	°C	-40		85
Operational Temperature at Case	T_C	°C	0		30
Forward Current	I_F	mA			160
Reverse Voltage	V_R	V			0
Output Power (extracavity)	P_{opt}	mW			60

Measurement Conditions / Comments
Stress in excess of the Absolute Maximum Ratings can cause permanent damage to the device.

Recommended Operational Conditions

Parameter	Symbol	Unit	min	typ	max
Operational Temperature at Case	T_C	°C	15		20
Forward Current	I_F	mA			140

Measurement Conditions / Comments

Characteristics at $T_C = 20^\circ\text{C}$, BOL under recommended working condition

Parameter	Symbol	Unit	min	typ	max
Center Wavelength	λ_C	nm		670	
Tuning Range	$\Delta\lambda_{tun}$	nm	665		675
Output Power	P_{opt}	mW		50	
Polarization				TE	
Spatial Mode (transversal)				TEM00	

Measurement Conditions / Comments
The actual achieved wavelength and power are strongly influenced by the external cavity. eyP gives no guarantee on these parameters.
E field parallel to Pin 2 - Pin 3 - plane
Fundamental Mode

EYP-RWE-0670-00703-1000-SOT02-0000

Revision 1.22

2021-05-19

GAIN CHIPS AR coated Fabry-Perot Laser



Amplified Spontaneous Emission (ASE)

without external cavity



Parameter	Symbol	Unit	min	typ	max
Divergence parallel (FWHM)	$\Theta_{ }$			10	
Divergence perpendicular (FWHM)	Θ_{\perp}			29	
Monitor Detector Responsivity	I_{mon} / P_{ASE}	$\mu A/mW$	1		40

Measurement Conditions / Comments
 parallel to Pin 2 - Pin 3 plane (see p. 3)
 perpendicular to Pin 2 - Pin 3 plane (see p. 3)
 $U_{R MD} = 5 V$

Chip Parameter



Parameter	Symbol	Unit	min	typ	max
Cavity Length	L	μm		1000	
Reflectivity at Front Facet	R_{ff}			$3 \cdot 10^{-4}$	$1 \cdot 10^{-3}$

Measurement Conditions / Comments

EYP-RWE-0670-00703-1000-SOT02-0000

Revision 1.22

2021-05-19

GAIN CHIPS AR coated Fabry-Perot Laser



Package Dimensions

Parameter	Symbol	Unit	min	typ	max
Height of Emission Plane	h	mm	3.50	3.65	3.70
Excentricity of Emission Center	R	mm			0.12
Pin Length	L _{PIN}	mm		14	

Measurement Conditions / Comments

reference plane: top side of TO header
reference: center of outer diameter of header

Package Pinout

M-type

- 1 Laser Diode Cathode, Monitor Diode Cathode, Case
- 2 Photo Diode Anode
- 3 Laser Diode Anode

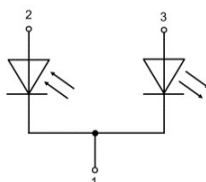

Bottom View

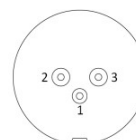

Package Drawings

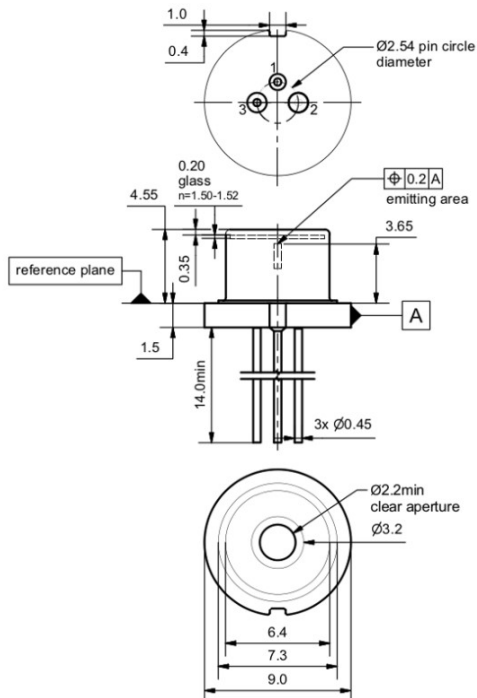

AIZ-16-0421-1517

EYP-RWE-0670-00703-1000-SOT02-0000

Revision 1.22

2021-05-19

GAIN CHIPS AR coated Fabry-Perot Laser



Typical Measurement Results

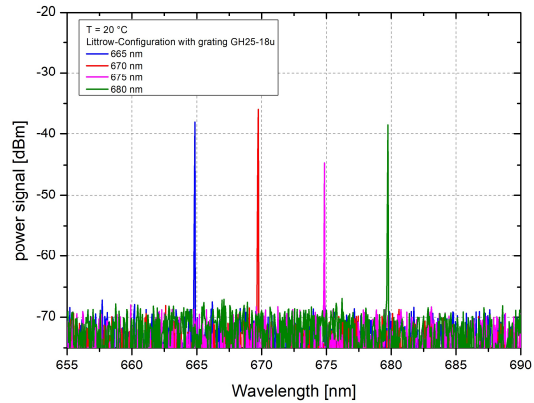
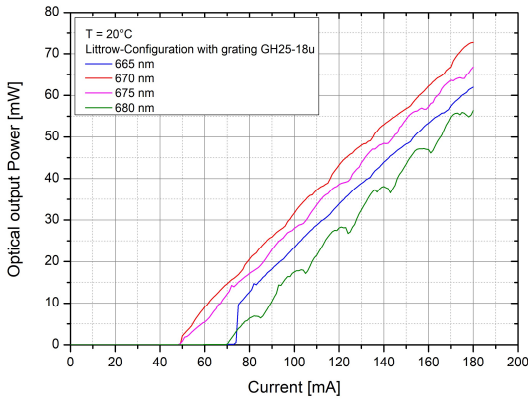

Performance figures, data and any illustrative material provided in this specification are typical and must be specifically confirmed in writing by eagleyard Photonics before they become applicable to any particular order or contract. In accordance with the eagleyard Photonics policy of continuous improvement specifications may change without notice.

Unpacking, Installation and Laser Safety

Unpacking the laser diodes should only be done at electrostatic safe workstations (EPA). Though protection against electro static discharge (ESD) is implemented in the laser package, charges may occur at surfaces. Please store this product in its original package at a dry, clean place until final use. During device installation, ESD protection has to be maintained.

The TPA diode type is known to be sensitive against thermal stress. It should not be operated without appropriate injection from a seed laser. Operating at moderate temperatures on proper heat sinks will contribute to a long lifetime of the diode. The chip should be protected against moisture. A water vapor content below 5000 ppm is recommended for applications with high reliability requirements.

The laser emission from this diode is close to the invisible infrared region of the electromagnetic spectrum. Avoid direct and/or indirect exposure to the free running beam. Collimating the free running beam with optics as common in optical instruments will increase threat to the human eye.

Each laser diode will come with an individual test protocol verifying the parameters given in this

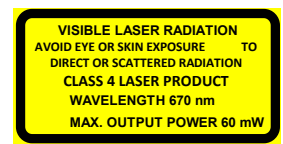
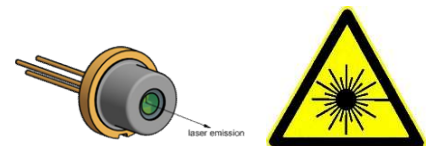

IEC-60825-0

