

SOA1140090YY22DBXXX

Broad-band Semiconductor Optical Amplifier

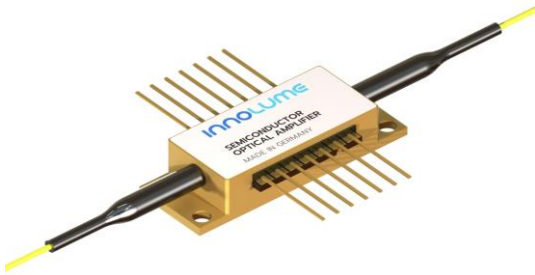

Features:

- Broad-band gain (90nm)
- 22dB gain and 15dBm saturation output power at wavelength of gain maximum
- Low ripples
- Strong linear polarization
- RoHS compliance
- Proprietary anti-reflection coating technology enabling high reliability
- Polarization maintaining PM980 fiber or HI1060 fiber
- 900um loose tube on fiber (optional)

Applications:

- Swept-source, tunable lasers
- Optical preamplifiers
- Optical coherence tomography (OCT)

Recommended Operating Conditions

@ CW, the case is mounted on room temperature heatsink

Parameter	Min.	Typ.	Max.	Unit
Chip Temperature	20	25	30	°C
Forward Current		400*	500	mA
Input Optical Power	-40	-25	10	dBm

* - current for maximum gain spectrum width might vary between batches

Gain Characteristics

@ CW, 25°C, 400mA*, with input signal -25dBm @ wavelength of gain maximum

Parameter	Min.	Typ.	Max.	Unit
Small Signal Gain @ 500mA	19	22		dB
Saturation Output Power (-3dB) @ 500mA	12	15		dBm
Gain Mean Wavelength	1125	1140	1155	nm
Gain Bandwidth (FWHM)	70	90		nm
Gain Spectrum Dip		5		dB
Noise Figure**		5		dB

** - $NF = 10 \log_{10}(2p_{ase}/G_{hv})$ [D.Baney et al., Optical Fiber Techn. 6, 122 (2000)]

Amplified Spontaneous Emission (ASE) Characteristics

@ CW, 25°C, 400mA*, no input signal

Parameter	Min.	Typ.	Max.	Unit
Output Power (each port)		4		mW
Forward Voltage		1.4	1.7	V
Mean Wavelength		1140		nm
Bandwidth (FWHM)		80		nm
Spectrum Dip		5		dB
Ground State Maximum Position		1170		nm
Excited State Maximum Position		1110		nm
Ripples*** (RMS)		0.02	0.3	dB
Polarisation Extinction Ratio (PER)	15	18		dB
Polarization		TE		

*** - measured in 1nm span around spectrum maximum with 20pm resolution

Absolute Maximum Ratings

Parameter	Min	Max	Unit
Output Optical Power		400	mW
Input Optical Power		20	dBm
Forward Current		1000	mA
Reverse Voltage		2	V
TEC Current		3	A
TEC Voltage		4	V
Chip Operating Temperature	10	40	°C
Case Operating Temperature	0	70	°C
Storage Temperature	-40	85	°C
Pin Soldering Temperature (max 10 sec, max case temperature 120°C)		300	°C
Fiber Band Radius	3		cm

Typical Performance (for reference only)

@ CW, the case is mounted on room temperature heatsink

Gain spectra at different currents

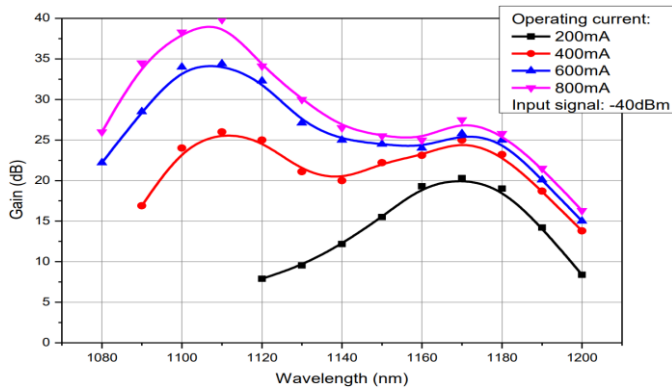

Gain and Output power vs. Input signal

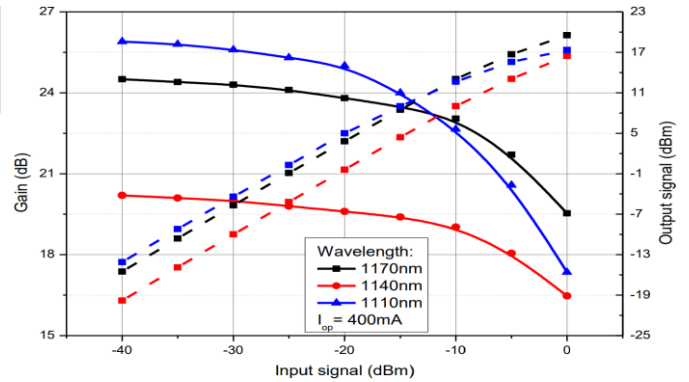

Gain spectra at different input signals

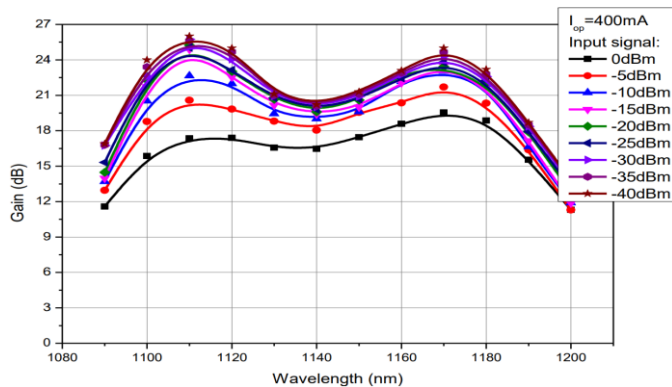

Spectra of amplified optical signal

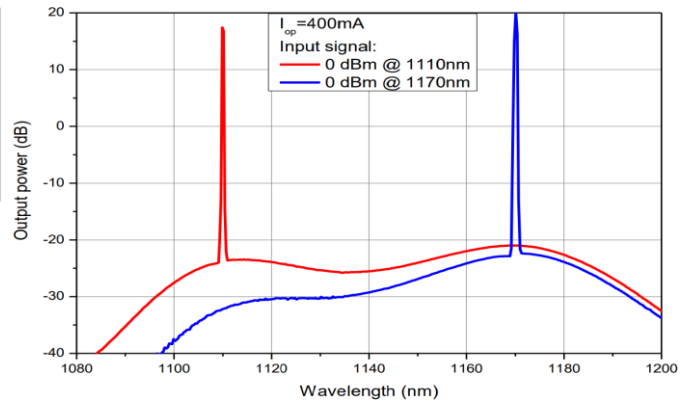

ASE Spectra (no input signal)

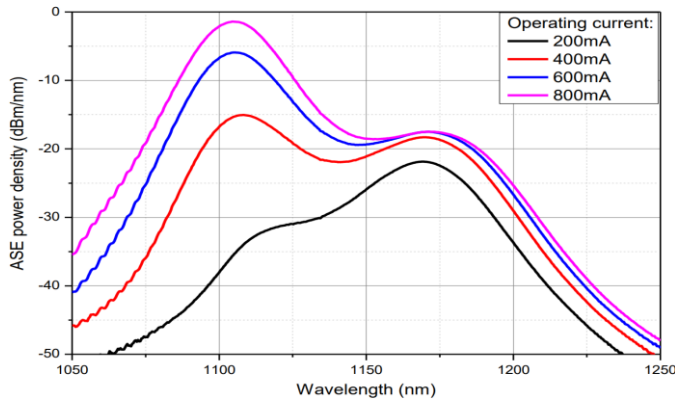

Output power at different input signals

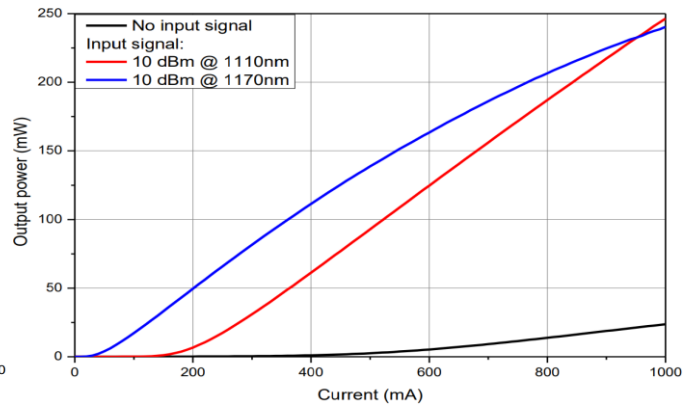

Thermistor specification			Fiber specification			
Parameters	Value	Unit	Parameters	Value	Value	Unit
Type	NTC		Fiber Type	HI1060	PM980	
Resistance @ 25°C	10±0.1	kOhm	Numerical Aperture (Typical)	0.14	0.12	
Beta 25-85°C	3435±1%	K	Cut-off Wavelength	920±50	900±70	nm
			Mode-Field Diameter	6.2±0.3 @1060nm	6.6±0.3 @1060nm	µm
			Cladding Diameter	125±1	125±1	µm
			Coating Diameter	245±15	245±15	µm
			Loose Tube Diameter (optional)	900	900	µm
			Connector	FC/APC	FC/APC	
			Key	narrow	narrow	

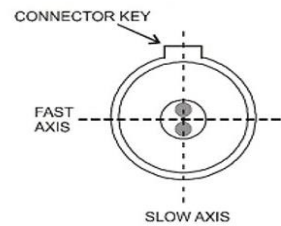
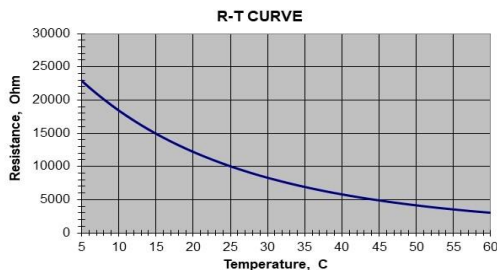

The output light is polarized along the slow axis of PM fiber.

Dimensions (in mm)

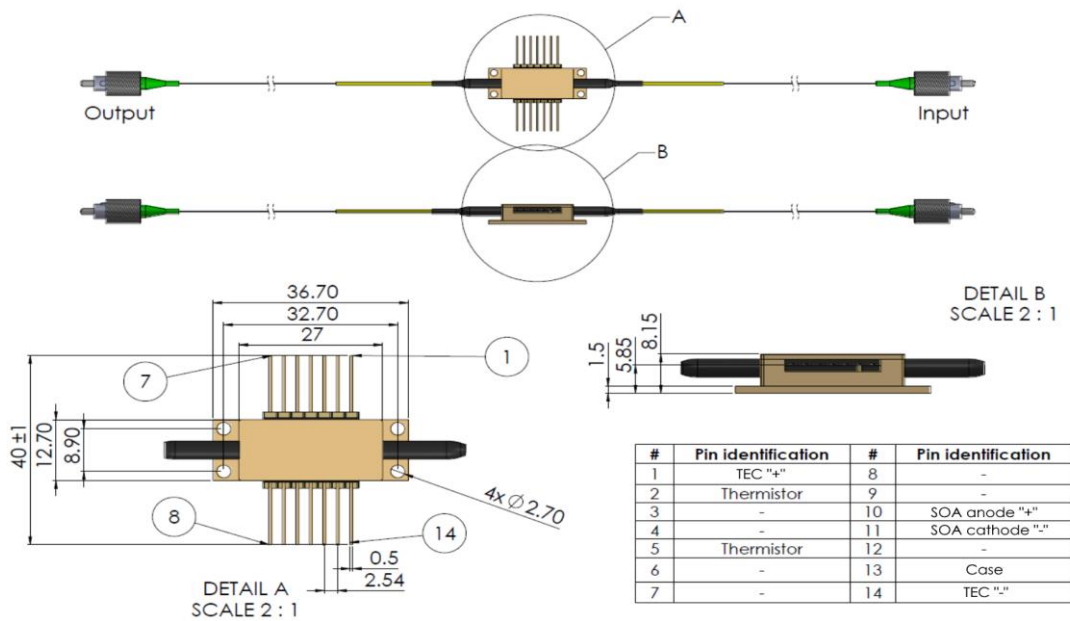

Safety and Operating Instructions

The light emitted from this device is invisible and can be harmful to the human eye. Avoid looking directly into the fiber connector when the device is in operation. Proper laser safety eyewear must be worn during operation with open connector. Absolute Maximum Ratings may be applied to the device for short period of time only. Exposure to maximum ratings for extended period of time or exposure to more than one maximum rating may cause damage or affect the reliability of the device. Operating the device outside of its maximum ratings may cause device failure or a safety hazard. Power supplies used with the component must be employed such that the maximum forward current cannot be exceeded.

A proper heatsink for the device on thermal radiator is required. The device must be mounted on radiator with 4 screws (bolt down in X-style fashion with initial torque set to 0.075Nm and final X-style bolt down at 0.15Nm) or with clamps. The deviation from flatness of radiator surface must be less than 0.05mm. It's recommended using of Indium foil or thermal conductive and soft material between bottom of the case and heatsink for thermal interface. It's undesirable to use thermal grease for this. Avoid back reflection to the device. It may give impact on the device performance in aspects of spectrum and power stability. It also may cause fatal facet damage. Using of optical isolators is highly recommended to block back reflection. Do not pull the fiber. Do not bend a fiber with a radius smaller than 3 cm. Fiber tip should always be protected from any contamination or damage during the process of installation. After removing the dust-preventing cap covered at fiber tip, carefully clean fiber tip by wiping through one direction using optical lens cleaning paper or cotton swab dabbed with Iso-Propanol or Ethyl alcohol. Operate the device with clean fiber connector only.

ESD PROTECTION - Electrostatic discharge is the primary cause of unexpected product failure. Take extreme precaution to prevent ESD. During device installation, ESD protection has to be maintained - use wrist straps, grounded work surfaces and rigorous antistatic techniques when handling the product.



Part-number Identification

SOA1140090HI22DBXXXX -> 1140nm gain mean wavelength, 90nm gain bandwidth, 22dB gain at wavelength of gain maximum, HI-1060 fiber

SOA1140090PM22DBLXXX -> 1140nm gain mean wavelength, 90nm gain bandwidth, 22dB gain at wavelength of gain maximum, PM-980 fiber, with loose tube

NOTE: Innolume product specifications are subject to change without notice