

## 2334 nm DFB Laser Specifications

Model Number: NL2334-B

### Operating Parameters

PARAMETER	UNITS	MIN.	MAX.
Storage Temperature	°C	-40	50
Case Operating Temperature	°C	-20	50
TEC Current	A		2.3
Laser Diode Forward Current	mA		200
Laser Diode Reverse Voltage	V		2

### Laser Characteristics

PARAMETER	CONDITION	UNITS	TYPICAL VALUE
Threshold Current	15 °C	mA	30
Operating Wavelength	115 mA & 15 °C	nm	2334± 1
Operating Power	115 mA & 15 °C	mW	1.5
Forward Voltage	115 mA & 15 °C	V	1.9
Thermistor Resistance	25 °C	kΩ	10 ± 0.1
Thermistor B constant	25 °C		3890
Temperature Tuning		nm/°C	0.20
Current Tuning	near 2327nm	nm/mA	0.05
Side Mode Suppression Ratio (SMSR)		dB	> 30

### Package:

- 14-pin Butterfly package, hermetically sealed
- AR coated Sapphire window, R<0.1%
- Internal TEC and thermistor
- Internal optical isolator
- 1.2 m long single mode fiber with FC/APC connector

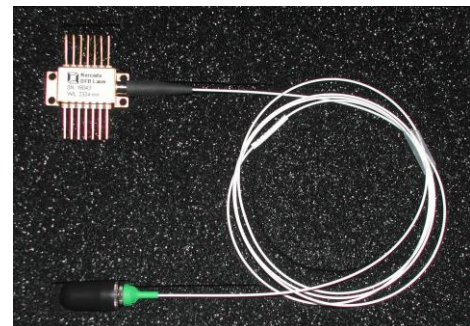

**Caution:** Laser diode produces invisible radiation during operation and is sensitive to electrostatic surge. Please read handling instruction carefully before working with the laser.

### Optical Power & Forward Voltage vs Drive Current at 15°C

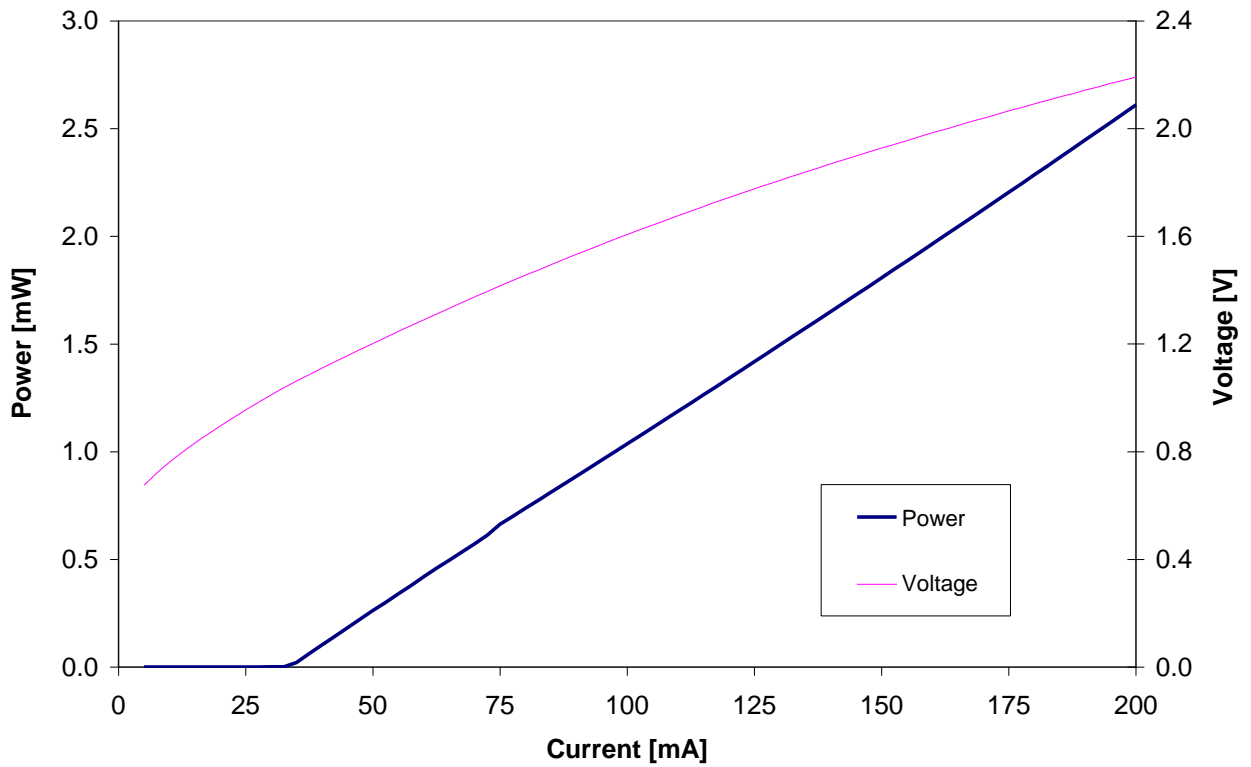

### Wavelength vs Drive Current

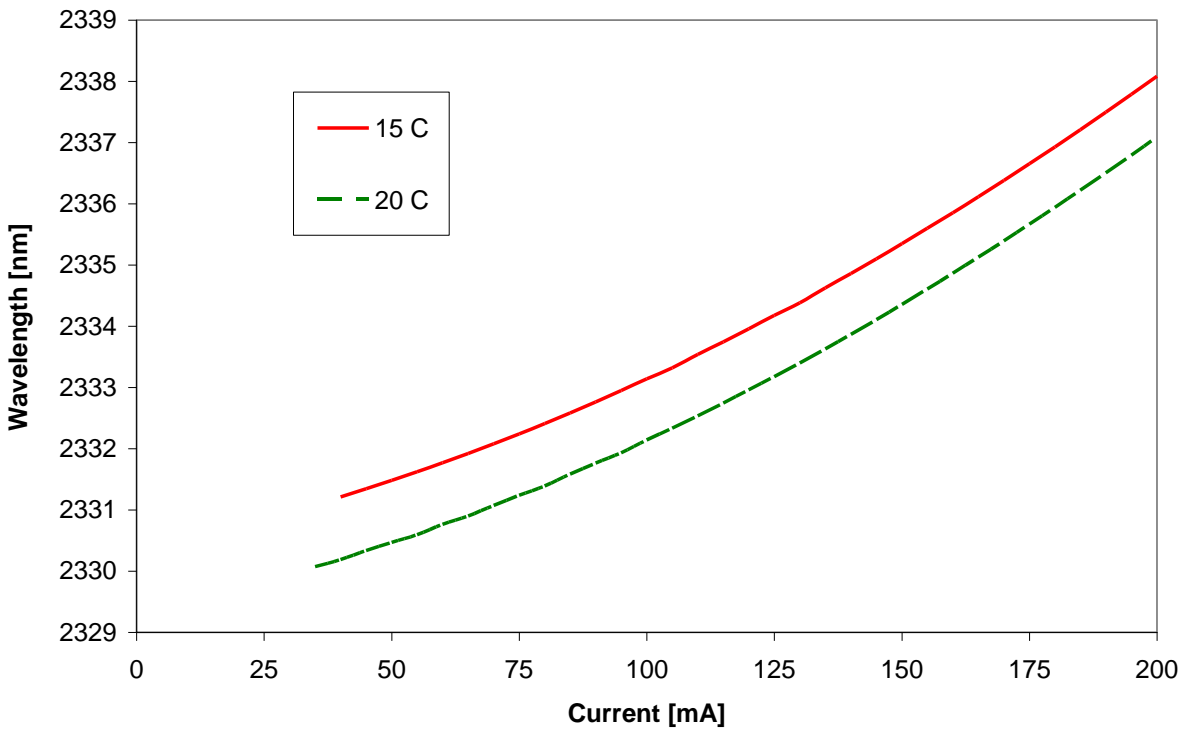

## Package Outline Diagram:

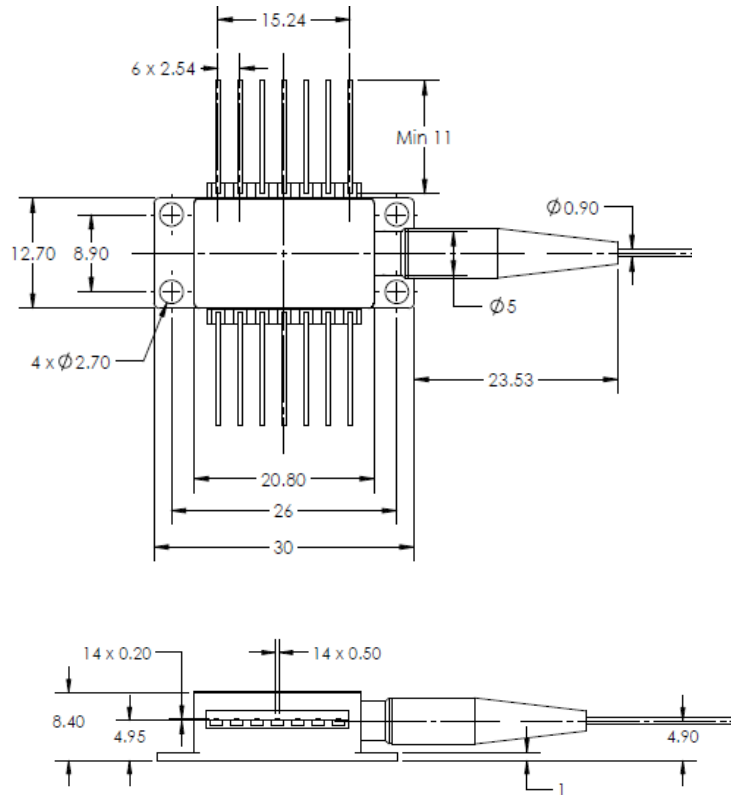

All dimensions are in mm

## Schematic Diagram:

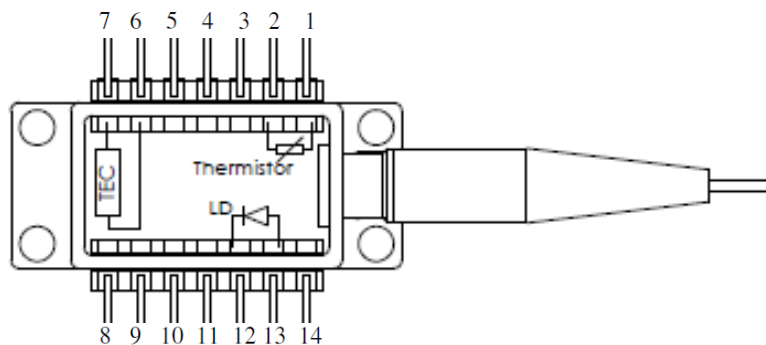

Pin #	Function	Pin #	Function
1	Thermistor	8	Not Used
2	Thermistor	9	Not Used
3	Not Used	10	Not Used
4	Not Used	11	Not Used
5	Not Used	12	Laser Diode Cathode (-)
6	TEC (+)	13	Laser Diode Anode (+)
7	TEC (-)	14	Not Used