

2334 nm DFB Laser Specifications

Model Number: NL2334-T

Operating Parameters

PARAMETER	UNITS	MIN.	MAX.
Storage Temperature	°C	-40	50
Case Operating Temperature	°C	-20	50
TEC Current	A		1.4
Laser Diode Forward Current	mA		200
Laser Diode Reverse Voltage	V		2

Laser Characteristics

PARAMETER	CONDITION	UNITS	TYPICAL VALUE
Threshold Current	15 °C	mA	30
Operating Wavelength	115 mA & 15 °C	nm	2334 ± 1
Operating Power	115 mA & 15 °C	mW	5
Forward Voltage	115 mA & 15 °C	V	1.9
Thermistor Resistance	25 °C	kΩ	10 ± 0.1
Thermistor B constant	25 °C		3890
Temperature Tuning		nm/°C	0.20
Current Tuning	near 2334 nm	nm/mA	0.05
Side Mode Suppression Ratio (SMSR)		dB	> 30

Package:

- TO-39 hermetically sealed
- AR coated sapphire window, R<0.1%
- Internal TEC and thermistor

Lens Option:

- Aspheric AR coated Lens, R<0.3%
- Beam diameter (1/e²): ~ 3 mm
- Beam collimation: < 1.0 mrad



Optical Power & Forward Voltage vs Drive Current at 15°C

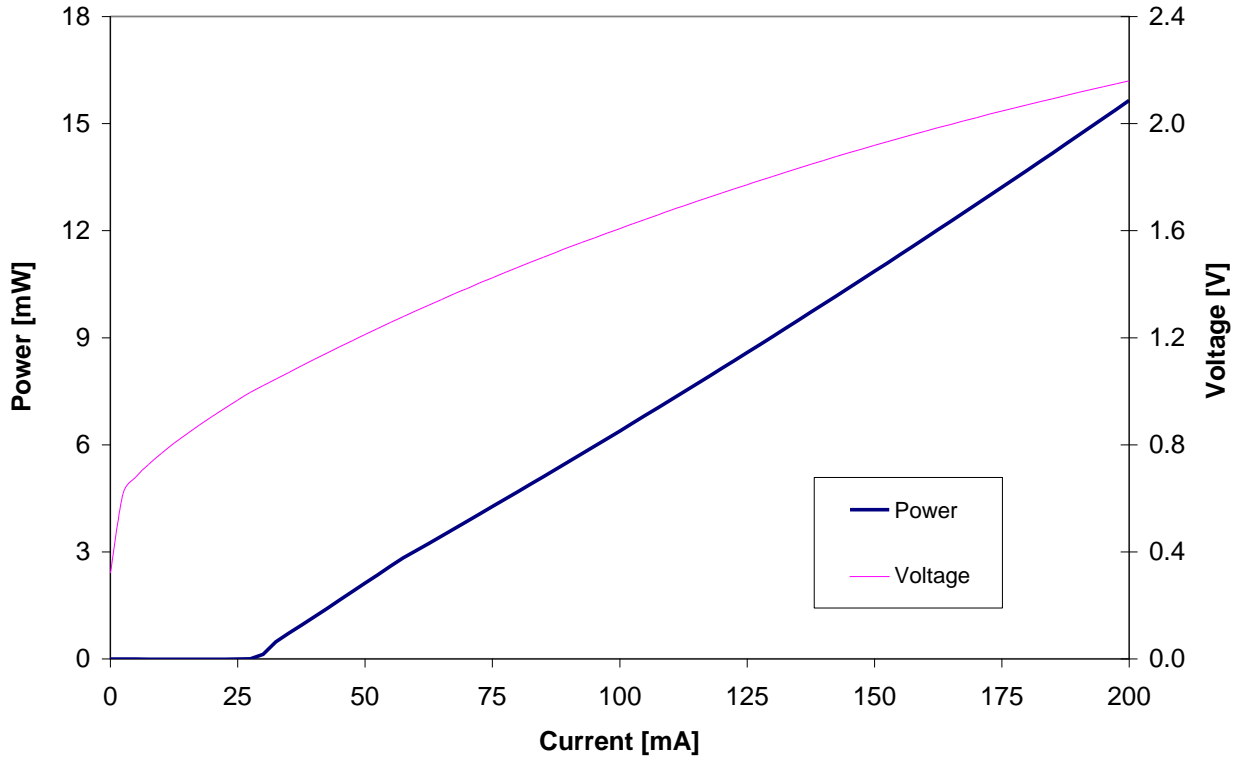

Wavelength vs Drive Current

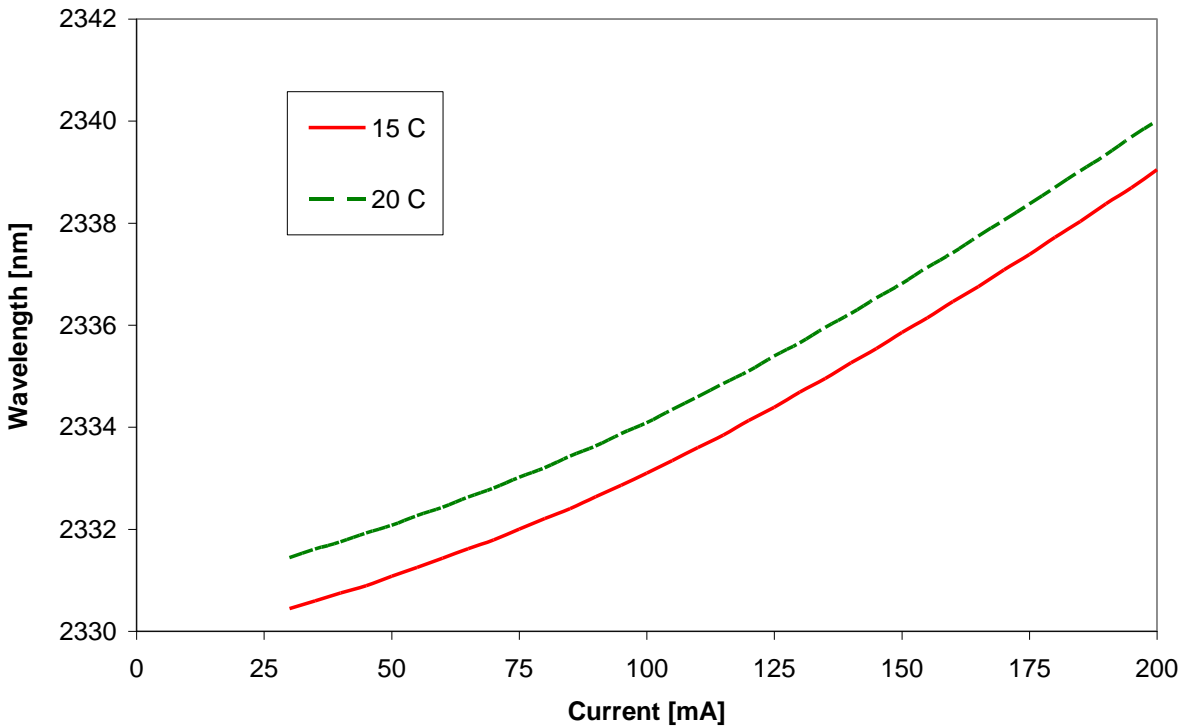

TO39 Package Outline Diagrams

Top View

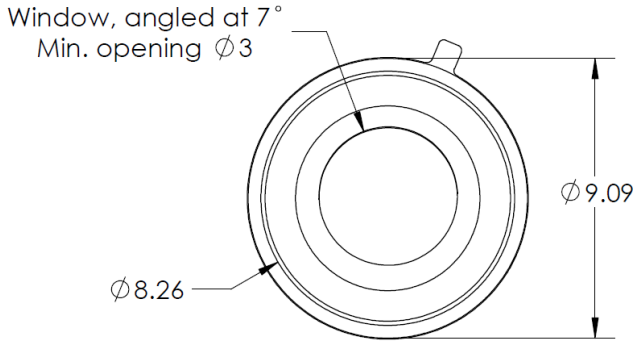

Bottom View

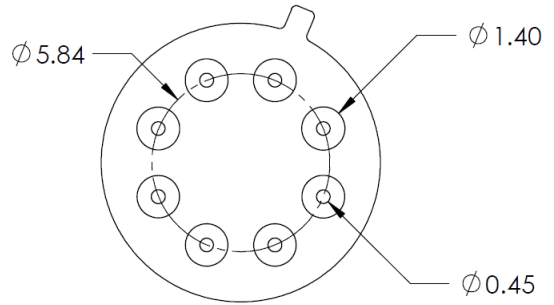

Front View

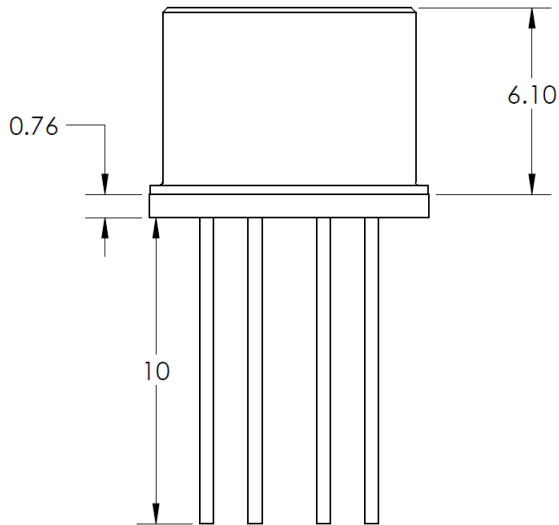

Schematic Diagram (Bottom View)

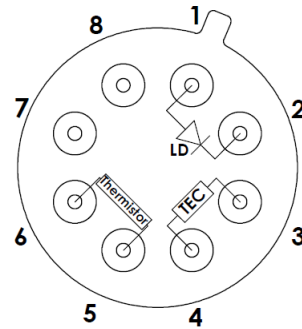

All dimensions in mm

Pin Number	Description
1	LD Anode (+)
2	LD Cathode (-)
3	TEC (-)
4	TEC (+)
5	Thermistor
6	Thermistor
7	Not Used
8	Not Used