



QLF093A-05A0/QLF093D-05A0

905 nm 100mW FP LASER TO-CAN

C00112-03 June 2022



1. DESCRIPTION

The QLF093x-05A0 series is a 905 nm quantum well laser device designed for high output power application. The laser diode is mounted into a TO-56 header including a monitor PD and hermetic sealed with a flat glass cap.

2. FEATURES

- 905 nm FP-LD
- $\Phi 5.6\text{mm}$ TO-CAN package
- High output power
- Lateral single mode
- Including monitor PD
- Two types of pin assignments: Anode common type (QLF093A-05A0)/cathode common type (QLF093D-05A0)

3. APPLICATIONS

- Sensing
- Industrial application

4. ABSOLUTE MAXIMUM RATING

(CW operation, $T_c = 25^\circ\text{C}$, unless otherwise specified)

PARAMETER	SYMBOL	RATING	UNIT
Optical output power	$P_o(\text{CW})$	150	mW
	$P_o(\text{Pulse})^*$	300	mW
LD reverse voltage	V_{RLD}	2	V
PD reverse voltage	V_{RPD}	30	V
Operation temperature	T_c	-10 to 70	$^\circ\text{C}$
Storage temperature	T_{stg}	-40 to 85	$^\circ\text{C}$

*note : Pulse width < 100nsec, Duty < 50%

5. OPTICAL AND ELECTRICAL CHARACTERISTICS

 (T_c = 25°C, unless otherwise specified)

PARAMETER	SYMBOL	TEST CONDITION	MIN	TYP	MAX	UNIT
Threshold current	I _{th}	CW	-	30	55	mA
Operation current	I _{op}	CW, P _o =100mW	-	137	160	mA
Operation voltage	V _{op}	CW, P _o =100mW	-	2.5	3.0	V
Slope efficiency	η	CW, P _o =5 - 100mW	0.8	0.9	-	W/A
Monitor current	I _m	CW, P _o =100mW, V _{RD} =5 V	50	350	600	μA
Peak wavelength	λ _p	CW, P _o =100mW	885	905	915	nm
Far filed pattern, horizontal	θ _h	CW, P _o =100mW	8	11	14	deg.
Far filed pattern, vertical	θ _v	CW, P _o =100mW	14	17	20	deg.
Tilt angle, horizontal	dθ _h	CW, P _o =100mW	-3	-	3	deg.
Tilt angle, vertical	dθ _v	CW, P _o =100mW	-3	-	3	deg.
Emitting point accuracy	Δx, Δy, Δz	-	-50	-	50	μm

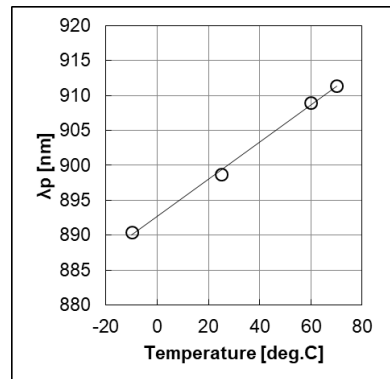
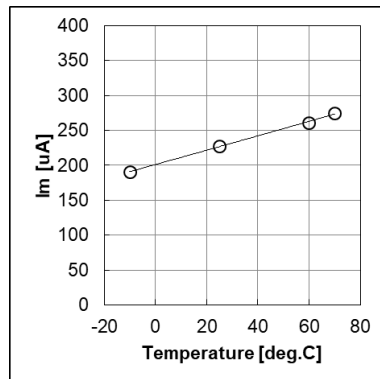
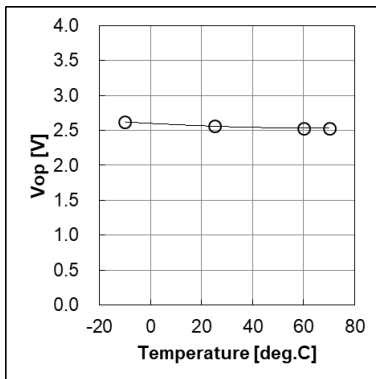
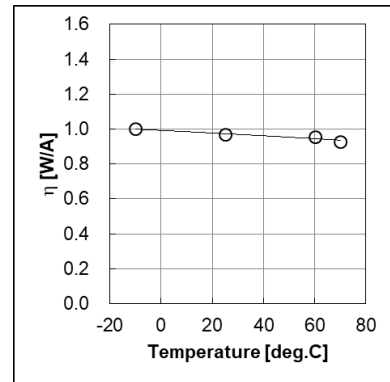
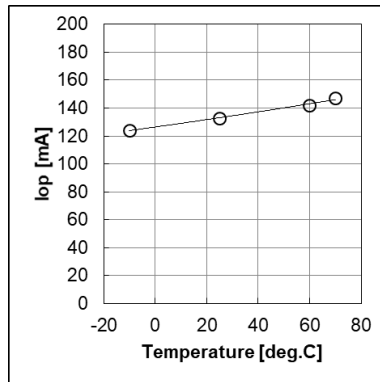
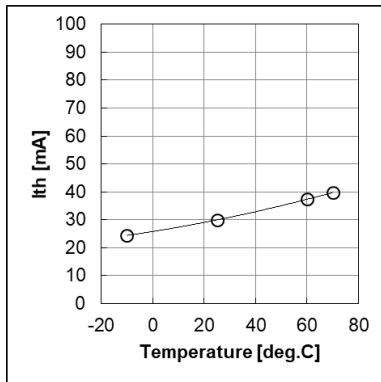

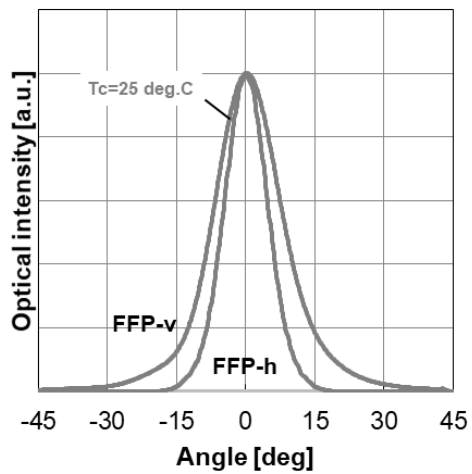
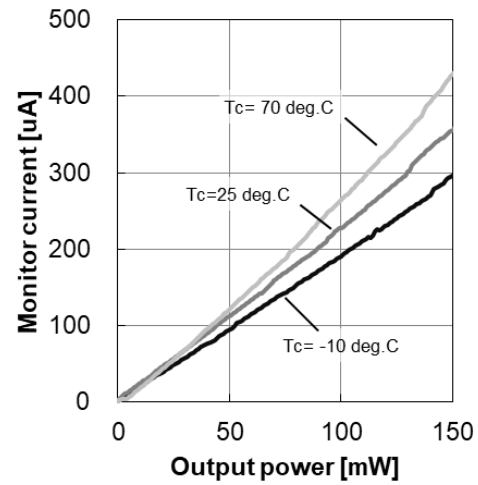
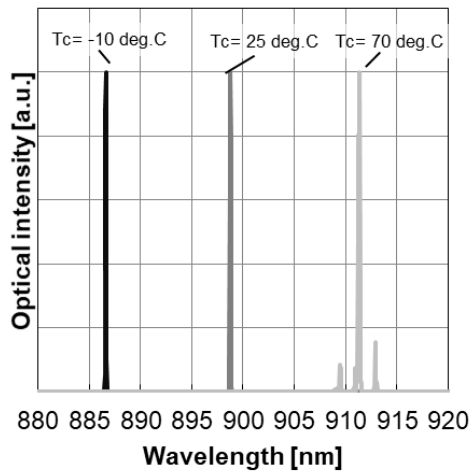
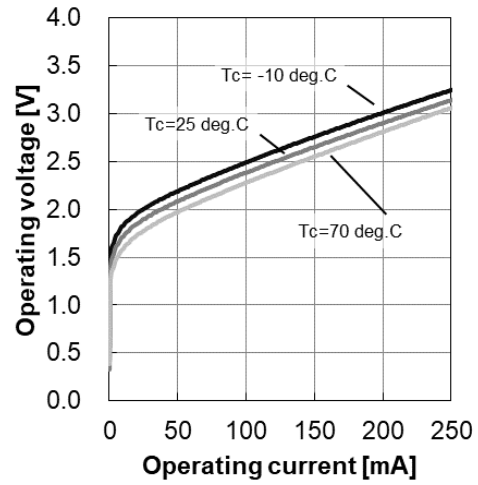
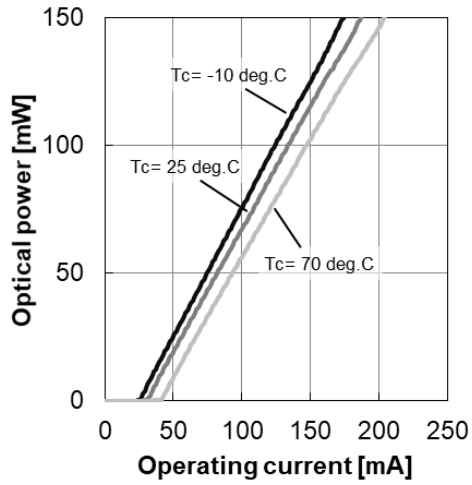

6. Outline Drawing

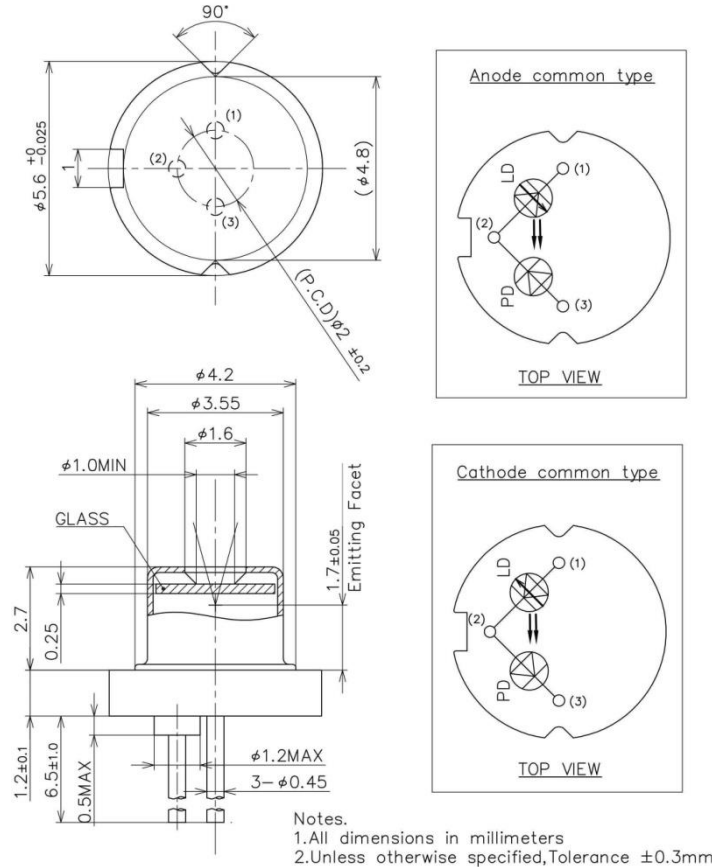

7. Notice

• Safety Information

This product is classified as Class 3B laser product, and complies with 21 CFR Part 1040.10. Please do not take a look at laser lighting in operations since laser devices may cause troubles to human eyes. Please do not eat, burn, break and make chemical process of the products since they contain GaAs material.

• Handling products

Semiconductor lasers are easily damaged by external stress such as excess temperature and ESD. Please pay attention to handling products, and use within range of maximum ratings. QD Laser takes no responsibility for any failure or unusual operation resulting from improper handling, or unusual physical or electrical stress.

• RoHS

This product conforms to RoHS compliance related Directive (EU) 2015/863.

QD Laser, Inc.

Contact : info@qdlaser.com <http://www.qdlaser.com>

Copyright 2013-2022 All Rights Reserved by QD Laser, Inc.

Keihin Bldg. 1F 1-1 Minamiwatarida-cho, Kawasaki-ku, Kawasaki, Kanagawa Zip 210-0855 Japan

All company or product names mentioned herein are trademarks or registered trademarks of their respective owners. Information provided in this data sheet is accurate at time of publication and is subject to change without advance notice.